

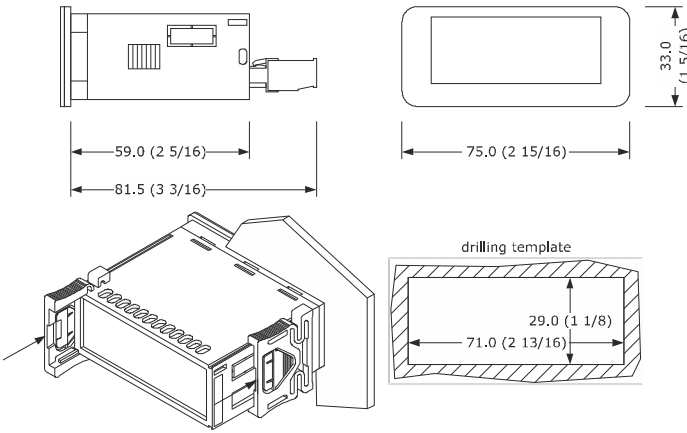

- EN ENGLISH**
- 230 VAC or 115 VAC power supply (according to the model)
 - 2 analogue inputs (PTC/NTC)
 - door switch/multi-purpose input
 - main relay 16 A res. @ 250 VAC
 - alarm buzzer
 - TTL MODBUS slave port for EVconnect app, EPOCA remote monitoring system or for BMS hot or cold mode regulation.

1 MEASUREMENTS AND INSTALLATION

Measurements in mm (inches). To be fitted to a panel, snap-in brackets provided.



INSTALLATION PRECAUTIONS

- the thickness of the panel must be between 0.8 and 2.0 mm (1/32 and 1/16 in)
- ensure that the working conditions are within the limits stated in the *TECHNICAL SPECIFICATIONS* section
- do not install the device close to heat sources, equipment with a strong magnetic field, in places subject to direct sunlight, rain, damp, excessive dust, mechanical vibrations or shocks
- in compliance with safety regulations, the device must be installed properly to ensure adequate protection from contact with electrical parts. All protective parts must be fixed in such a way as to need the aid of a tool to remove them.

2 ELECTRICAL CONNECTION

- N.B.**
- use cables of an adequate section for the current running through them
 - to reduce any electromagnetic interference, locate the power cables as far away as possible from the signal cables.

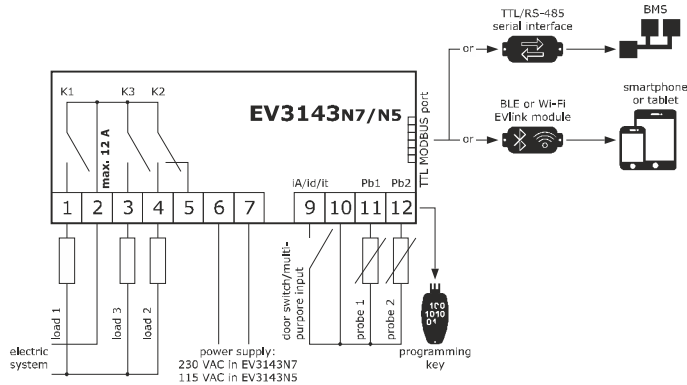

The controller is operated mainly by P10 (default "controller with two independent regulators").

P10	OPERATION	PROBE 1	PROBE 2	LOAD 1	LOAD 2	LOAD 3
0	controller with two independent regulators	regulator 1	regulator 2	regulator 1	regulator 2	alarm
1	controller for refrigerated milk storage units	tank	auxiliary	compressor	auxiliary	beater
2	controller for ice cream batch freezers	tank	plate	compressor	plate heaters	beater

PRECAUTIONS FOR ELECTRICAL CONNECTION

- if using an electrical or pneumatic screwdriver, adjust the tightening torque
- if the device is moved from a cold to a warm place, humidity may cause condensation to form inside. Wait for about an hour before switching on the power
- make sure that the supply voltage, electrical frequency and power are within the set limits. See the section *TECHNICAL SPECIFICATIONS*
- disconnect the power supply before carrying out any type of maintenance
- do not use the device as a safety device
- for repairs and for further information, contact the EVCO sales network.

3 FIRST-TIME USE

1. Carry out the installation following the instructions given in the section *MEASUREMENTS AND INSTALLATION*.
2. Power up the device as set out in the section *ELECTRICAL CONNECTION*: an internal test will start up. The test normally takes a few seconds; when it is finished the display will switch off.
3. Configure the device as shown in the section *Setting configuration parameters*.

Recommended configuration parameters for first-time use:

PAR.	DEF.	PARAMETER	MIN... MAX.
SP1	0.0	load 1 setpoint	r1... r2
SP2	0.0	load 2 setpoint	r12... r13
SP3	0.0	beater setpoint	r16... r17
P0	1	type of probe	0 = PTC 1 = NTC
P2	0	temperature measurement unit	0 = °C 1 = °F
P10	0	operating logic	0 = controller with two independent regulators 1 = controller for refrigerated milk storage units 2 = controller for ice cream batch freezers

Then check that the remaining settings are appropriate; see the section *CONFIGURATION PARAMETERS*.

4. Disconnect the device from the mains.
5. Make the electrical connection as shown in the section *ELECTRICAL CONNECTION*, without powering up the device.
6. For the connection in an RS-485 network connect the interface EVIF22TSX or EVIF23TSX, to use the device with the EPOCA remote monitoring system, connect the EVIF25TWX module, to use the device with the APP EVconnect connect the interface EVIF25TBX; see the relevant instruction sheets. **If EVIF22TSX or EVIF23TSX is used, set parameter BLE to 0.**
7. Power up the device again.

4 USER INTERFACE AND MAIN FUNCTIONS

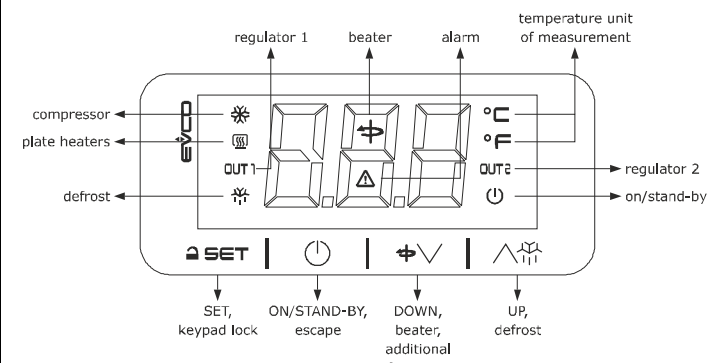

4.1 Switching the device on/off

1. If POF = 1 (default), touch the ON/STAND-BY key for 4 s.
If the device is switched on, the display will show the P5 value ("probe 1 temperature" default); if the display shows an alarm code, see the section *ALARMS*.

LED	ON	OFF	FLASHING
	compressor on	compressor off	- compressor protection in progress - setpoint being set
	plate heaters on	plate heaters off	setpoint being set
OUT1	regulator 1 on	regulator 1 off	- load 1 protection in progress - setpoint being set
	defrost active	-	-
	beater on	beater off	setpoint being set
	alarm active and silenced	-	alarm active and not silenced
°C/°F	temperature displayed	-	-
OUT2	regulator 2 on	regulator 2 off	- load 2 protection in progress - setpoint being set
	device off	device on	device being switched on/off

When 30 s have elapsed without the keys being pressed, the display will show the "Loc" label and the keypad will automatically lock.

4.2 Unlocking the keypad

Touch a key for 1 s: the display will show the label "UnL".

4.3 Quick setting:

- of setpoints (if P9 = 1 or 3)
- beater switch on/off times (if P9 = 2 or 3)

Check that the keypad is not locked.

1. Touch the SET key: the display will show the label "SP1".
2. Touch the UP or DOWN key within 15 s to set the load 1 setpoint value within the limits r1 and r2 (default "-50... 50").
3. Touch the SET key: the display will show the label "SP2".
4. Touch the UP or DOWN key within 15 s to set the load 2 setpoint value within the limits r12 and r13 (default "-50... 50").
5. Touch the SET key: the display will show the label "SP3".
6. Touch the UP or DOWN key within 15 s to set the beater setpoint value within the limits r16 and r17 (default "-50... 50").
7. Touch the SET key: the display will show the label "t0".
8. Touch the UP or DOWN key within 15 s to set the time the beater is switched off within the limits 0... 240 min.
9. Touch the SET key: the display will show the label "t1".
10. Touch the UP or DOWN key within 15 s to set the time the beater is switched on within the limits 0... 240 min.
11. Touch the SET key (or take no action for 15 s).

Settings are temporary: when the device is switched back on (and after a power failure), it resets the values SP1, SP2, SP3, t0 and t1.

4.4 Starting up/interrupting batch freezing (if P10 = 2)

Check that the keypad is not locked.

1. Touch the ON/STAND-BY key.

4.5 Manually switching on the beater (if P10 = 1)

Check that the keypad is not locked.

1. Touch the DOWN key for 4 s.

The beater is switched on for time t1.

4.6 Activating manual defrost (if r5 and/or r19 = 0, default)

Check that the keypad is not locked.

1. Touch the UP key for 4 s.

4.7 Silencing the buzzer (if Pbu = 2 or 3)

Touch a key.
If u4 = 1, the alarm output is also deactivated.

5 OPERATION

5.1 Controller with two independent regulators (P10 = 0, default)

Cold mode regulation regulator 1 (r5 = 0).

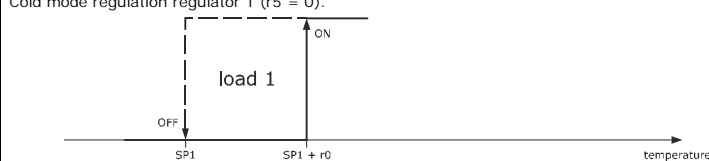

Hot mode regulation regulator 1 (r5 = 1).

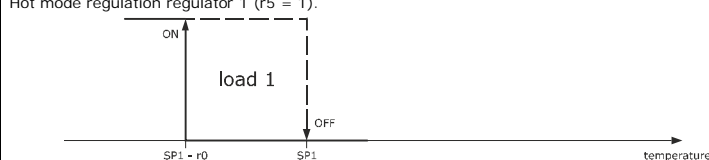

Cold mode regulation regulator 2 (r10 = 0).

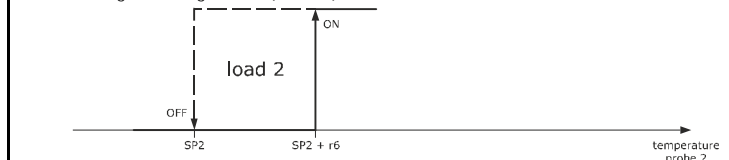

Hot mode regulation regulator 2 (r10 = 1).



5.2 Controller for refrigerated milk storage units (P10 = 1)

Compressor operation.

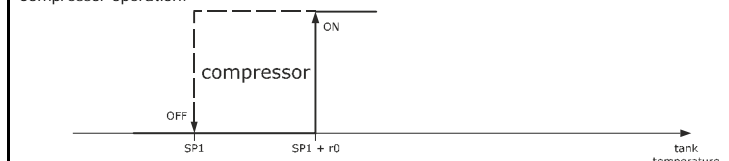

Beater operation set to t0 and t1 (r14 = 0).

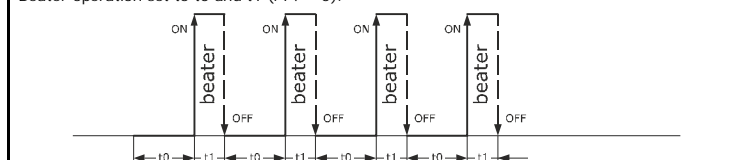

Beater operation set to r19, t0 and t1 if beater setpoint is not reached (r14 = 1).

Cold mode regulation beater (r19 = 0)

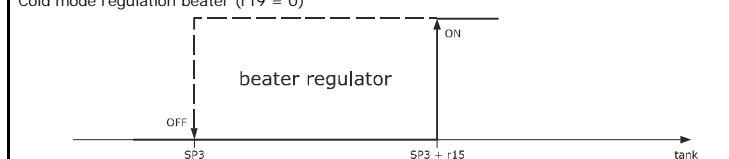

Beater operation set to r19, t0 and t1 if beater setpoint is not reached (r14 = 1).

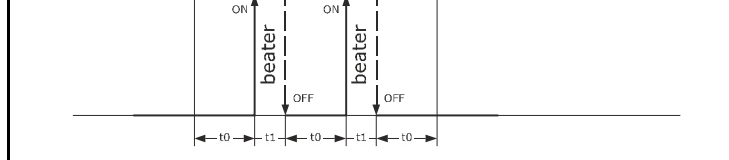

Hot mode regulation (r19 = 1).

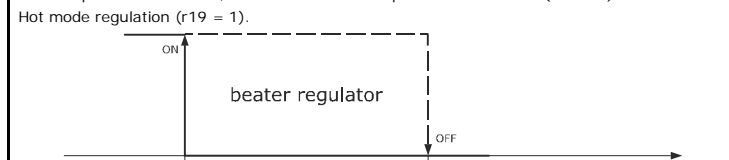

5.3 Controller for ice cream batch freezers (P10 = 2)

The batch freezing cycle consists of 4 phases:

- heating
- cooking
- cooling
- conservation.

5.3.1 Heating

The compressor remains off.

Plate heaters operation.

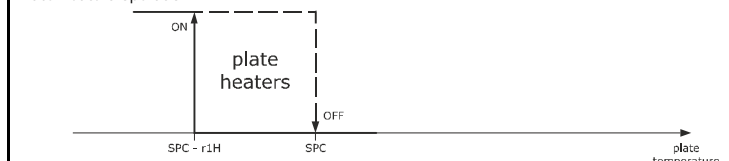

Beater operation.

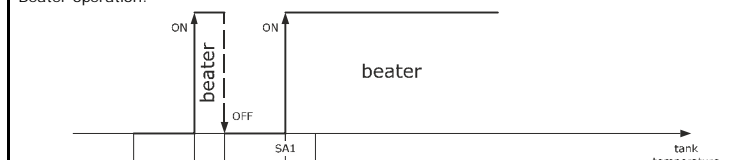

End of phase.

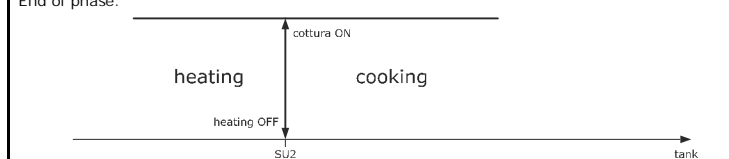

At the end of the phase the buzzer emits 10 beeps 1 s long.

If there is a power failure during the phase, it starts back up again from the beginning.

5.3.2 Cooking

The compressor remains off.

Plate heaters operation.

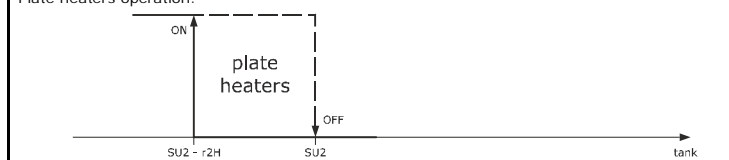

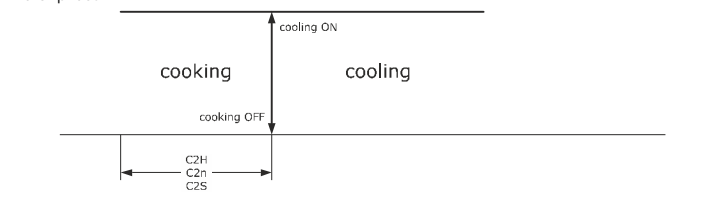
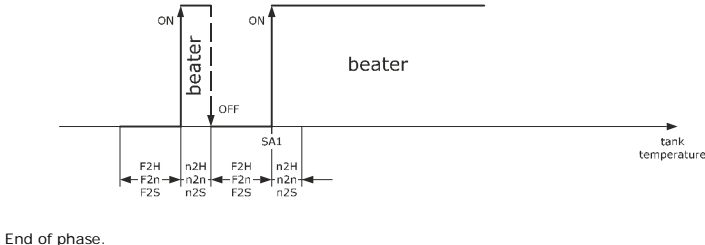

At the end of the phase the buzzer emits 10 beeps 1 s long.
If there is a power failure during the phase, it starts back up again from the beginning.

5.3.3 Cooling

Compressor operation.

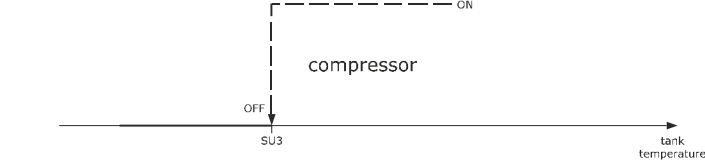

The plate heaters remain off.

Beater operation.

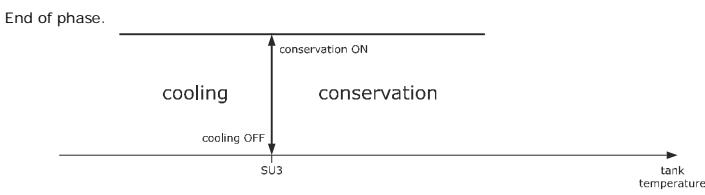
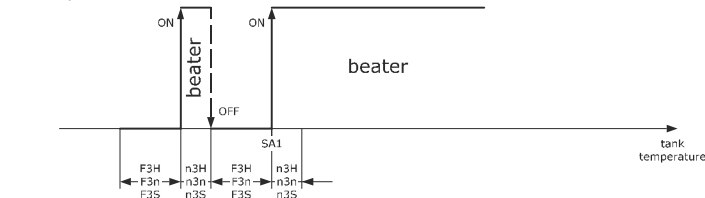

At the end of the phase the buzzer emits 10 beeps 1 s long.
If there is a power failure during the phase:
- the phase starts back up again from the beginning if (tank temperature after the power failure - tank temperature before the power failure) < Pfd
- the cycle starts back up again from the beginning of the heating phase if (tank temperature after the power failure - tank temperature before the power failure) > Pfd.

5.3.4 Conservation

Compressor operation.

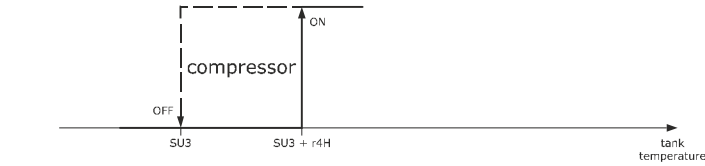

The plate heaters remain off.

Beater operation.

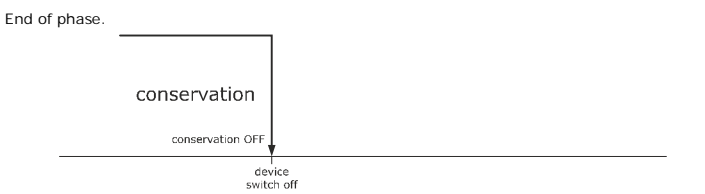
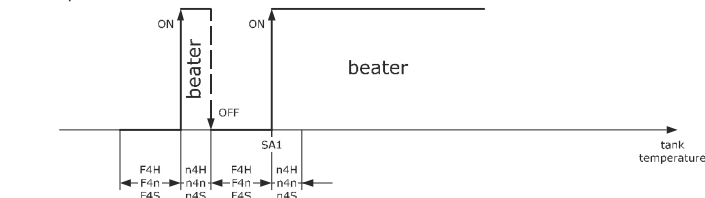

If there is a power failure during the phase:
- the phase starts back up again from the beginning if (tank temperature after the power failure - tank temperature before the power failure) < Pfd
- the cycle starts back up again from the beginning of the heating phase if (tank temperature after the power failure - tank temperature before the power failure) > Pfd.

6 ADDITIONAL FUNCTIONS

6.1 Viewing the temperatures detected by the probes

Check that the keypad is not locked.

- Touch the DOWN key for 4 s.
 - Touch the UP or DOWN key within 15 s to select a label.
- | LAB. | DESCRIPTION |
|------|---------------------|
| Pb1 | probe 1 temperature |
| Pb2 | probe 2 temperature |
- Touch the SET key.
 - Touch the ON/STAND-BY key (or take no action for 60 s) to exit the procedure.

7 SETTINGS

7.1 Setting configuration parameters

- Touch the SET key for 4 s: the display will show the label "PA".
- Touch the SET key.
- Touch the UP or DOWN key within 15 s to set the PAS value (default "-19").
- Touch the SET key (or take no action for 15 s): the display will show the label "SP1".
- Touch the UP or DOWN key to select a parameter.
- Touch the SET key.
- Touch the UP or DOWN key within 15 s to set the value.

- Touch the SET key (or take no action for 15 s).
 - Touch the SET key for 4 s (or take no action for 60 s) to exit the procedure.
- ### 7.2 Restoring factory (default) settings and saving customised settings
- N.B.
- check that the factory settings are appropriate; see the section *CONFIGURATION PARAMETERS*.
- saving customised settings overwrites the factory settings.
- Touch the SET key for 4 s: the display will show the label "PA".
 - Touch the SET key.
 - Touch the UP or DOWN key within 15 s to set the value.
- | VAL. | MEANING |
|------|-------------------------------------------------------|
| 149 | value for restoring the factory information (default) |
| 161 | value for saving customised settings |
- Touch the SET key (or take no action for 15 s): the display will show the label "dEF" (for setting the "149" value) or the label "MAP" (for setting the "161" value).
 - Touch the SET key.
 - Touch the UP or DOWN key within 15 s to set the value.
- | VAL. | MEANING |
|------|------------------------------------------------|
| 1 | controller with two independent regulators |
| 2 | controller for refrigerated milk storage units |
| 3 | controller for ice cream batch freezers |
- Touch the SET key (or take no action for 15 s): the display will show "- - -" flashing for 4 s, after which the device will exit the procedure.
 - Disconnect the device from the power supply.
 - Touch the SET key for 2 s before action 6 to exit the procedure beforehand.

8 CONFIGURATION PARAMETERS

N.B.
- DEF. 1: default values for P10 = 0
- DEF. 2: default values for P10 = 1
- DEF. 3: default values for P10 = 2
Access to parameter P10 causes the restoration of the default values.

NO.	PAR.	DEF. 1	DEF. 2	DEF. 3	SETPOINT	MIN... MAX.
1	SP1	0.0	0.0	- - -	load 1 setpoint	r1... r2
2	SP2	0.0	0.0	- - -	load 2 setpoint	r7... r8
3	SP3	- - -	0.0	- - -	beater setpoint	r16... r17
NO.	PAR.	DEF. 1	DEF. 2	DEF. 3	ANALOGUE INPUTS	MIN... MAX.
4	CA1	0.0	0.0	0.0	probe 1 offset	-25... 25 °C/°F
5	CA2	0.0	0.0	0.0	probe 2 offset	-25... 25 °C/°F
6	P0	1	1	1	type of probe	0 = PTC 1 = NTC
7	P1	1	1	1	enable decimal point °C	0 = no 1 = yes
8	P2	0	0	0	temperature measurement unit	0 = °C 1 = °F
9	P3	2	2	- - -	probe 1 function not visible if P10 = 2	0 = disabled 1 = tank probe 2 = regulator 1 3 = condenser probe
10	P4	2	2	- - -	probe 2 function not visible if P10 = 2	0 = disabled 1 = plate probe 2 = regulator 2 3 = condenser probe
11	P5	0	0	0	value displayed	0 = probe 1 temperature 1 = probe 2 temperature 2 = load 1 setpoint 3 = load 2 setpoint
12	P8	5	5	5	display refresh time	0... 250 s: 10
13	P9	0	0	0	enable quick settings block	0 = disabled 1 = setpoint 2 = beater on/off times 3 = beater on/off setpoint + times
14	P10	0	1	2	operating logic	0 = controller with two independent regulators 1 = controller for refrigerated milk storage units 2 = controller for ice cream batch freezers
NO.	PAR.	DEF. 1	DEF. 2	DEF. 3	REGULATION	MIN... MAX.
15	r0	2.0	2.0	- - -	load 1 setpoint differential	1... 15 °C/°F
16	r1	-50	-50	- - -	load 1 minimum setpoint	-99 °C/°F... r2
17	r2	50.0	50.0	- - -	load 1 maximum setpoint	r1... 150 °C/°F
18	r5	0	0	- - -	hot or cold mode regulation regulator 1	0 = cold mode 1 = hot mode
19	r6	2.0	2.0	- - -	load 2 setpoint differential	1... 15 °C/°F
20	r7	-50	-50	- - -	load 2 minimum setpoint	-99 °C/°F... r8
21	r8	50.0	50.0	- - -	load 2 maximum setpoint	r7... 150 °C/°F
22	r9	1	1	- - -	enable regulator 2	0 = no 1 = yes if P10 = 1
23	r10	0	0	- - -	hot or cold mode regulation regulator 2	0 = cold mode 1 = hot mode
24	r14	- - -	0	- - -	beater mode in normal operation	0 = parameter set to t0 and t1 1 = parameter set to r19, t0, t1 if the beater setpoint is not reached
25	r15	- - -	0.5	- - -	beater setpoint differential	1... 15 °C/°F
26	r16	- - -	-50	- - -	beater minimum setpoint	-99 °C/°F... r17
27	r17	- - -	50	- - -	beater maximum setpoint	r16... 150 °C/°F
28	r19	- - -	0	- - -	hot or cold mode regulation beater	0 = cold mode 1 = hot mode
29	r20	- - -	0	- - -	beater mode in beater probe alarm	0 = off 1 = set to t0 and t1
30	r21	- - -	0	- - -	constraint between beater and compressor	0 = disabled 1 = on if compressor on and parameter set to r14 2 = on if compressor off and parameter set to r14 3 = on if compressor on
NO.	PAR.	DEF. 1	DEF. 2	DEF. 3	BEATER	MIN... MAX.
31	t0	- - -	3	- - -	beater off time	0... 240 min
32	t1	- - -	2	- - -	beater on time	0... 240 min

33	t2	- - -	0	- - -	beater off delay from compressor off	0... 240 min
34	t3	- - -	10	- - -	minimum beater on and off time	0... 240 s
NO.	PAR.	DEF. 1	DEF. 2	DEF. 3	LOADS	MIN... MAX.
35	C0	3	3	3	load 1 on delay from power-on	0... 240 min
36	C1	5	5	5	delay between two load 1 switch-ons	0... 240 min
37	C2	3	3	3	load 1 minimum off time	0... 240 min
38	C3	0	0	0	load 1 minimum on time	0... 240 s
39	C4	10	10	- - -	load 1 off time in probe 1 alarm	0... 240 min if C6 = 2
40	C5	10	10	- - -	load 1 on time in probe 1 alarm	0... 240 min if C6 = 2
41	C6	3	3	- - -	load 2 on delay from power-on and load 2 minimum off time	0... 240 min
42	C7	0	0	- - -	load 2 minimum on time	0... 240 s
43	C8	5	5	- - -	delay between two load 2 switch-ons	0... 240 min
44	C10	0	0	- - -	load 2 off time in probe 2 alarm	0... 240 min if C6 = 2
45	C11	0	0	- - -	load 2 on time in probe 2 alarm	0... 240 min if C6 = 2
46	C13	80.0	80.0	- - -	high condensation signal threshold not visible if P10 = 2	0... 199 °C/°F differential = 2 °C/4 °F
47	C14	90.0	90.0	- - -	high condensation alarm threshold	0... 150 °C/°F
48	C15	60	60	- - -	high condensation alarm delay	0... 240 s
NO.	PAR.	DEF. 1	DEF. 2	DEF. 3	DEFROSTING (if r5 = 0)	MIN... MAX.
49	d0	8	8	- - -	automatic defrost interval regulator 1 and regulator 2	0... 99 h 0 = manual only
50	d3	30	30	- - -	defrost duration regulator 1	0... 99 min
51	d4	0	0	- - -	enable defrost at power-on	0 = no 1 = yes
52	d5	0	0	- - -	defrost delay from power-on	0... 99 min
53	d6	2	2	- - -	value displayed when defrosting	0 = value P5 (if P5 = 0 or 1) 1 = value P5 (if P5 = 0 or 1) at defrost activation 2 = label dEF
54	d10	30	- - -	- - -	defrost duration regulator 2	0... 99 min
55	d12	0	- - -	- - -	constraint between defrost regulator 1 and defrost regulator 2	0 = disabled 1 = regulator defrost is activated only if defrost of the other regulator is not in progress. If it is, it waits for this to end.
NO.	PAR.	DEF. 1	DEF. 2	DEF. 3	ALARMS	MIN... MAX.
56	A1	-10.0	-10.0	-10.0	low temperature alarm threshold probe 1	-99... 150 °C/°F
57	A2	0	0	0	type of low temperature alarm probe 1	0 = disabled 1 = relative to load 1 setpoint 2 = absolute
58	A4	10.0	10.0	10.0	high temperature alarm threshold probe 1	-99... 150 °C/°F
59	A5	0	0	0	type of high temperature alarm probe 1	0 = disabled 1 = relative to load 1 setpoint 2 = absolute
60	A6	12	12	12	high temperature alarm delay probe 1 from power-on	0... 99 minx10
61	A7	15	15	15	high/low temperature alarm delay probe 1	0... 240 min
62	A8	15	15	15	high temperature alarm delay probe 1 after defrosting regulator 1	0... 240 min
63	A10	- - -	- - -	- - -	unused	-
64	A11	-10.0	-10.0	-10.0	low temperature alarm threshold probe 2	-99... 150 °C/°F
65	A12	0	0	0	type of low temperature alarm probe 2	0 = disabled 1 = relative to load 2 setpoint 2 = absolute
66	A14	10.0	10.0	10.0	high temperature alarm threshold probe 2	-99... 150 °C/°F
67	A15	0	0	0	type of high temperature alarm probe 2	0 = disabled 1 = relative to load 2 setpoint 2 = absolute
68	A16	12	12	12	high temperature alarm delay probe 2 from power-on	0... 99 minx10
69	A17	15	15	15	high/low temperature alarm delay probe 2	0... 240 min
70	A18	15	15	15	high temperature alarm delay probe 2 after defrosting regulator 2	0... 240 min
71	A19	2.0	2.0	2.0	high/low temperature alarm reset differential	1... 15 °C/°F
NO.	PAR.	DEF. 1	DEF. 2	DEF. 3	DIGITAL INPUTS	MIN... MAX.
72	i2	30	30	30	door switch/multi-purpose input alarm signal delay	0... 120 min
73	i3	15	15	15	maximum compressor and beater off time with door switch/multi-purpose input active	0... 120 min
74	i5	3	3	3	door switch/multi-purpose input function	0 = disabled 1 = compressor off 2 = beater off 3 = multi-purpose input alarm 4 = switches device on/off 5 = thermal switch alarm 6 = door open alarm

NO.	PAR.	DEF. 1	DEF. 2	DEF. 3	BATCH FREEZER	MIN... MAX.
75	i6	0	0	0	activation door switch/multi-purpose input	0 = with contact closed 1 = with contact open
76	i7	0	0	0	door switch/multi-purpose input alarm activation delay	0... 120 min
77	u1	3	0	0	K1 relay configuration	0 = compressor 1 = plate heaters 2 = beater 3 = load 1 4 = load 2 5 = alarm
78	u2	4	4	1	K2 relay configuration	as u1
79	u3	5	2	2	K3 relay configuration	as u1
80	u4	1	1	1	enable silencing alarm output	0 = no 1 = yes
81	Snd	---	---	30	threshold for neutral zone regulation during cooking	99... 150 °C/°F
82	d2n	---	---	1.0	neutral zone value	0... 99.0 °C/°F
83	r23	---	---	0.0	minimum plate setpoint during batch freezing heating and cooking	0 °C/°F... r24
84	r24	---	---	130	maximum plate setpoint during batch freezing heating and cooking	r23... 150 °C/°F
85	r25	---	---	0.0	minimum tank setpoint at end of batch freezing heating and batch freezing cooking setpoint	0 °C/°F... r26
86	r26	---	---	90.0	maximum tank setpoint at end of batch freezing heating and batch freezing cooking setpoint	r25... 150 °C/°F
87	r27	---	---	0.0	minimum tank setpoint at end of batch freezing cooling and tank setpoint during conservation	-2 °C/°F... r28
88	r28	---	---	130	maximum tank setpoint at end of batch freezing cooling and tank setpoint during conservation	r27... 60 °C/°F
89	SA1	---	---	50.0	tank setpoint for beater on or on/off during batch freezing	-99... 150 °C/°F differential = 5 °C/10 °F
90	PfD	---	---	5.0	difference in tank temperature after power failure during batch freezing cooling or conservation due to re-activating heating	1... 25 °C/°F
91	r1H	---	---	2.0	plate differential setpoint during batch freezing heating and plate setpoint during batch freezing cooking	1... 25 °C/°F
92	n1H	---	---	0	hours beater on during batch freezing heating	0... 23 h
93	n1n	---	---	2	minutes beater on during batch freezing heating	0... 59 min
94	n1S	---	---	0	seconds beater on during batch freezing heating	0... 59 s
95	F1H	---	---	0	hours beater off during batch freezing heating	0... 23 h
96	F1n	---	---	2	minutes beater off during batch freezing heating	0... 59 min
97	F1S	---	---	0	seconds beater off during batch freezing heating	0... 59 s
98	SPC	---	---	30.0	plate setpoint during batch freezing cooking and plate setpoint during batch freezing cooking	r23... r24
99	SU2	---	---	30.0	tank setpoint at end of batch freezing heating and tank setpoint during batch freezing cooking	r25... r26
100	r2H	---	---	2.0	tank differential setpoint during batch freezing cooking	1... 25 °C/°F
101	C2H	---	---	1	duration in hours of batch freezing cooking	0... 23 h
102	C2n	---	---	0	duration in minutes of batch freezing cooking	0... 59 min
103	C2S	---	---	0	duration in seconds of batch freezing cooking	0... 59 s
104	n2H	---	---	0	hours beater on during batch freezing cooking	0... 23 h
105	n2n	---	---	2	minutes beater on during batch freezing cooking	0... 59 min

NO.	PAR.	DEF. 1	DEF. 2	DEF. 3	BATCH FREEZING COOLING	MIN... MAX.
106	n2S	---	---	0	seconds beater on during batch freezing cooking	0... 59 s
107	F2H	---	---	0	hours beater off during batch freezing cooking	0... 23 h
108	F2n	---	---	2	minutes beater off during batch freezing cooking	0... 59 min
109	F2S	---	---	0	seconds beater off during batch freezing cooking	0... 59 s
110	SU3	---	---	30.0	tank setpoint at end of batch freezing cooling and tank setpoint during batch freezing conservation	r27... r28
111	SA3	---	---	10.0	tank setpoint for beater on at end of batch freezing cooking	0... 25 °C/°F
112	n3H	---	---	0	hours beater on during batch freezing cooling	0... 23 h
113	n3n	---	---	2	minutes beater on during batch freezing cooling	0... 59 min
114	n3S	---	---	0	seconds beater on during batch freezing cooling	0... 59 s
115	F3H	---	---	0	hours beater off during batch freezing cooling	0... 23 h
116	F3n	---	---	2	minutes beater off during batch freezing cooling	0... 59 min
117	F3S	---	---	0	seconds beater off during batch freezing cooling	0... 59 s
118	r4H	---	---	2.0	tank differential setpoint during batch freezing conservation	1... 25 °C/°F
119	n4H	---	---	0	hours beater on during batch freezing conservation	0... 23 h
120	n4n	---	---	2	minutes beater on during batch freezing conservation	0... 59 min
121	n4S	---	---	0	seconds beater on during batch freezing conservation	0... 59 s
122	F4H	---	---	0	hours beater off during batch freezing conservation	0... 23 h
123	F4n	---	---	2	minutes beater off during batch freezing conservation	0... 59 min
124	F4S	---	---	0	seconds beater off during batch freezing conservation	0... 59 s
125	F4C	---	---	0	beater mode during batch freezing conservation	0 = independent on the compressor 1 = on if compressor on, according to n4... and F4... if compressor off
126	HE4	60	0	0	timeout for locking the keypad	0... 240 s
127	POF	1	1	1	enable ON/STAND-BY key	0 = no 1 = yes
128	PAS	-19	-19	-19	password	-99... 999
129	PA1	---	---	---	unused	-
130	PA2	---	---	---	unused	-
131	Hr0	---	---	---	unused	-
132	rE0	15	15	15	data-logger sampling interval	0... 240 min
133	rE1	1	1	1	recorded temperature	0 = none 1 = probe 1 2 = probe 2 3 = all
134	LA	247	247	247	MODBUS address	1... 247
135	Lb	2	2	2	MODBUS baud rate	0 = 2,400 baud 1 = 4,800 baud 2 = 9,600 baud 3 = 19,200 baud
136	bLE	1	1	1	serial port configuration for connectivity	0 = free 1 = forced for EVconnect or EPoCA 2-99 = EPoCA local network address
137	bu1	---	0	---	duration of buzzer activation when setpoint reached	0... 240 s
138	Pbu	3	3	2	enable buzzer	0 = disabled 1 = keys only 2 = alarms only 3 = keys and alarms

CODE	DESCRIPTION	RESET	TO CORRECT
Pr1	probe 1 alarm	automatic	- check P0
Pr2	probe 2 alarm	automatic	- check integrity of the probe - check electrical connection
rtc	unused	unused	unused
AL1	low temperature alarm probe 1	automatic	check A1 and A2
AH1	high temperature alarm probe 1	automatic	check A4 and A5
AL2	low temperature alarm probe 2	automatic	check A11 and A12
AH2	high temperature alarm probe 2	automatic	check A14 and A15
id	door open alarm	automatic	check i5 and i6

PF	power failure alarm	manual	- touch a key - check electrical connection
COH	high condensation signal	automatic	check C13
CSD	high condensation alarm	manual	- switch the device off and on - check C14
IA	multi-purpose input alarm	automatic	check i5 and i6
it	thermal switch alarm	automatic	- switch the device off and on - check i5 and i6
10 TECHNICAL SPECIFICATIONS			
Purpose of the control device:		function controller.	
Construction of the control device:		built-in electronic device.	
Housing:		black, self-extinguishing.	
Category of heat and fire resistance:		D.	
Measurements:			
75.0 x 33.0 x 59.0 mm (2 15/16 x 1 5/16 x 2 5/16 in) with fixed screw terminal blocks		75.0 x 33.0 x 81.5 mm (2 15/16 x 1 5/16 x 3 3/16 in) with plug-in screw terminal blocks	
Mounting methods for the control device:		to be fitted to a panel, snap-in brackets provided	
Degree of protection provided by the casing:		IP65 (front).	
Connection method:			
fixed screw terminal blocks for wires up to 2.5 mm ²	plug-in screw terminal blocks for wires up to 2.5 mm ² (on request)	Micro-MaTch connector	
Maximum permitted length for connection cables:			
power supply: 10 m (32.8 ft)		analogue inputs: 10 m (32.8 ft)	
digital inputs: 10 m (32.8 ft)		digital outputs: 10 m (32.8 ft)	
Operating temperature:		from 0 to 55 °C (from 32 to 131 °F).	
Storage temperature:		from -25 to 70 °C (from -13 to 158 °F).	
Operating humidity:		relative humidity without condensate from 10 to 90%.	
Pollution status of the control device:		2.	
Compliance:			
RoHS 2011/65/EC	WEEE 2012/19/EU	REACH (EC) Regulation no. 1907/2006	
EMC 2014/30/EU		LVD 2014/35/EU.	
Power supply:			
230 VAC (+10% -15%), 50/60 Hz (±3 Hz), max. 2 VA insulated in EV3143N7			
115 VAC (+10% -15%), 50/60 Hz (±3 Hz), max. 2 VA insulated in EV3143N5.			
Earthing methods for the control device:			
Rated impulse-withstand voltage:		4 KV.	
Over-voltage category:		III.	
Software class and structure:		A.	
Analogue inputs:			
PTC probes:		2 for PTC or NTC probes (probe 1 and probe 2).	
Type of sensor:	KTY 81-121 (990 Ω @ 25 °C, 77 °F)		
Measurement field:	from -50 to 150 °C (from -58 to 302 °F)		
Resolution:	0.1 °C (1 °F).		
NTC probes:			
Type of sensor:	β3435 (10 KΩ @ 25 °C, 77 °F)		
Measurement field:	from -40 to 105 °C (from -40 to 221 °F)		
Resolution:	0.1 °C (1 °F).		
Digital inputs:			
Dry contact:		Type of contact:	5 VDC, 1.5 mA
		Power supply:	none
		Protection:	none.
Digital outputs:			
K1 relay:		SPST, 16 A res. @ 250 VAC	
K2 relay:		SPDT, 8 A res. @ 250 VAC.	
K3 relay:		SPST, 5 A res. @ 250 VAC.	
Type 1 or Type 2 actions:		type 1.	
Additional features of Type 1 or Type 2 actions:		C.	
Displays:		custom display, 3 digit, with function icons.	
Alarm buzzer:		built-in.	
Communications ports:		1 TTL MODBUS slave port for EVconnect app, EPoCA remote monitoring system or for BMS.	
N.B. The device must be disposed of according to local regulations governing the collection of electrical and electronic equipment.			
This document and the solutions contained therein are the intellectual property of EVCO and thus protected by the Italian Intellectual Property Rights Code (CPI). EVCO imposes an absolute ban on the full or partial reproduction and disclosure of the content other than with the express approval of EVCO. The customer (manufacturer, installer or end user) assumes all responsibility for the configuration of the device. EVCO accepts no liability for any possible errors in this document and reserves the right to make any changes at any time without prejudice to the essential functional and safety features of the equipment.			
EVCO		EVCO S.p.A. Via Feltre 81, 32036 Sedico (BL) ITALY Tel. +39 0437/8422 Fax +39 0437/83648 email info@evco.it web www.evco.it	